

Data Sheet



Article number: 604133032040

Description: Taper bored timing belt pulley
HTD 32 14M 40 TL 2012

Measures

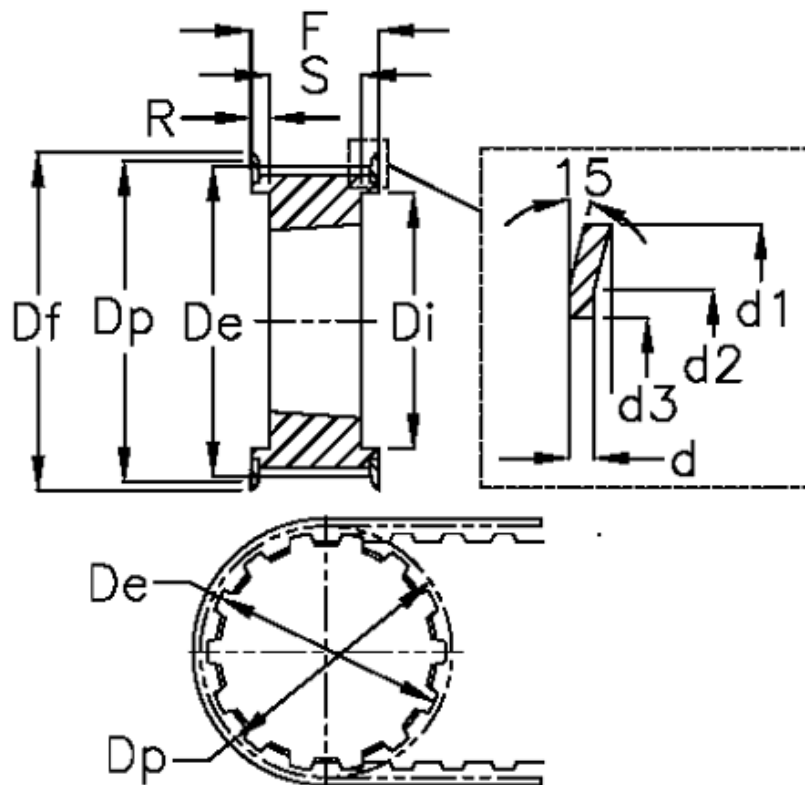

d = 2.5	F = 54	Weight = 3.4
d1 = 154	Flange type = F49	Width = 40
d2 = 142	For bushing = 2012	
d3 = 122	Max bore = 50	
De = 139.88	r = 11	
Df = 154	S = 32	
Di = 108	Tooth number = 32	
Dp = 142.6	Type = 14M	